

Digi-SENSE[®]

Thermistor Thermometer

MODEL NO. 93210-00

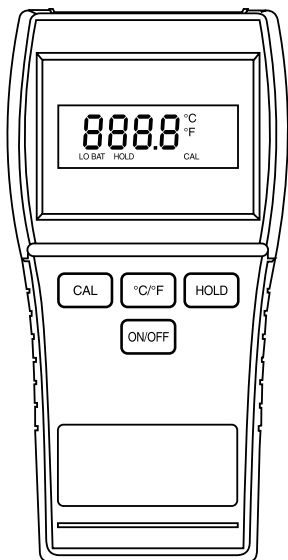

Cole-Parmer Instrument Co.

625 East Bunker Court
Vernon Hills, Illinois U.S.A. 60061-1844

(847) 549-7600

(847) 247-2929 (Fax)

800-323-4340

www.coleparmer.com

e-mail: techinfo@coleparmer.com

A-1299-0867

Edition 01



68X309902 R.0 08/03

CERTIFICATE OF CONFORMANCE

This thermometer was calibrated using equipment traceable to the National Institute of Standards and Technology (NIST).

This instrument conforms to
ITS-90.



The accuracy of the thermometer at the time of calibration was within specifications stated in the operating manual.

Model No.: _____

Serial Number: _____

Date placed in service: _____

To purchase an NIST certificate of traceability with test data and test date for meter and probe please contact:

Cole-Parmer Instrument Company
625 East Bunker Court
Vernon Hills, Illinois USA 60061-1844

Toll-free: 800-323-4340

ISO 9001
SUPPLIER CERTIFIED

INTRODUCTION

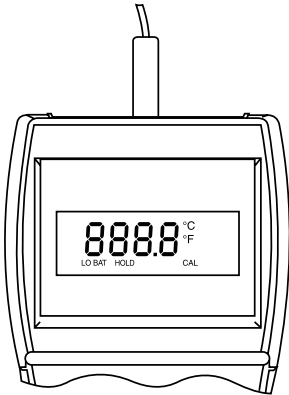



This versatile hand-held instrument provides highly accurate temperature measurements. The instrument is designed for easy operation and includes the following features:

- Operator selection of Celsius or Fahrenheit scale
- Resolution of 0.1°
- Four-digit LCD
- Hold feature for temporarily retaining a reading
- Field calibration capability
- Low battery warning
- Built-in tilt stand for easy hands-free operation
- Standard 1/4 inch (6.3mm) phone jack connector input
- Operates with a wide selection of probes

SAFETY PRECAUTIONS

 **DANGER** *VOLTAGES PRESENT AT THE THERMISTORS MAY ALSO BE PRESENT AT THE BATTERY TERMINALS. ALWAYS DISCONNECT THE THERMOCOUPLE WHEN CHANGING BATTERIES.*

 **WARNING** *THIS INSTRUMENT IS DESIGNED TO ACCEPT LOW LEVEL SIGNALS SUPPLIED BY STANDARD 400 SERIES THERMISTORS. UNDER NO CIRCUMSTANCES SHOULD THE INPUT VOLTAGE EXCEED THE SPECIFIED 10 V RMS.*

 **CAUTION** *DO NOT USE OR STORE THIS INSTRUMENT IN MICROWAVE OVENS OR ANY ABNORMALLY HOT OR COLD AREAS.*

 **CAUTION** *WEAK BATTERIES SHOULD NOT BE LEFT IN THE INSTRUMENT. DEAD BATTERIES CAN LEAK AND CAUSE DAMAGE TO UNIT.*

SPECIFICATIONS

THERMISTOR PROBES

YSI 400 series (2252 ohm at 25°C)
-40.0 °C to 125.0 °C (-40.0 °F to 257.0 °F)

Out of range display: "Ur", "Or", "oPEn"

Resolution: 0.1°

Accuracy

±0.2 °C (±0.4 °F)

Display: 4-digit LCD with 0.4 inch high numerals.

Display update rate: 0.5 sec per update.

Input: One probe with 1/4 inch (6.3mm) phone jack connector.

Input Protection: 10V rms

Battery: Two AA, 1.5V alkaline ANSI-L40, IEC-LR6.

Battery Life: 200 hours continuous, typical.

Low battery indication

Battery Symbol on when 8 to 10 hours of battery life remains.

Auto Shutoff: 17 minutes after last key press.

Operating:

Stated accuracy: 18°C to 28°C (64°F to 82°F)

Useful range: 0°C to 40°C (32°F to 104°F)

Storage: -40°C to 65°C
(-40°F to 149°F)

Humidity: 10% to 90%

Dimensions

3 cm D x 8.4 cm W x 15.8 cm H
(1.2 in x 3.3 in x 6.2 in)

Weight with batteries: 227 grams (8 ounces)

Ingress protection: Meets IEC-529 IP-54 for dust- and water-resistant enclosures.

Compliance (For CE Mark): EN61326-1/A1: 1998
(EU EMC Directive)

BATTERY INSTALLATION AND REPLACEMENT

 **DANGER** *VOLTAGES PRESENT AT THE THERMISTOR MAY ALSO BE PRESENT AT THE BATTERY TERMINALS. ALWAYS DISCONNECT THE PROBE WHEN CHANGING BATTERIES.*

 **CAUTION** *WEAK BATTERIES SHOULD NOT BE LEFT IN THE INSTRUMENT. DEAD BATTERIES CAN LEAK AND CAUSE DAMAGE TO UNIT.*

If battery indicator turns on, battery life is approximately 8 to 10 hours.

See SPECIFICATIONS for battery type.

1. Before changing battery, turn instrument off and disconnect probe.
2. Loosen screw and lift battery cover off back of case.
3. Remove the two AA batteries.
4. Insert two new batteries observing polarity.
5. Install cover and tighten screw.

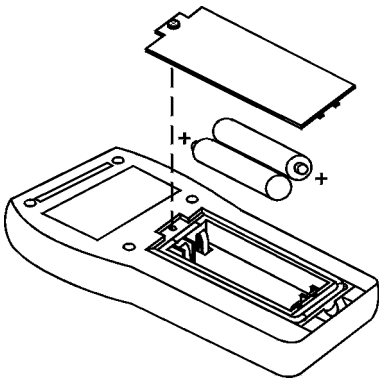

CONNECTING A THERMISTOR

Use the correct thermistor (series 400) for your instrument. Using an incorrect probe type will result in erroneous readings. (Series 500 thermistor probes may be used along with the supplied correction chart to convert meter readings to actual temperature). Insert the 1/4 inch plug into the mating connector on the top of the instrument.

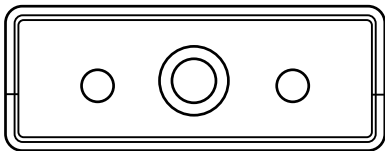

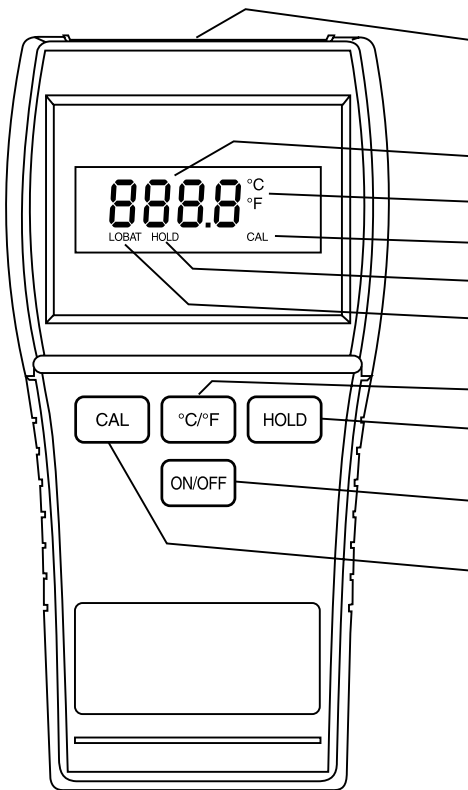

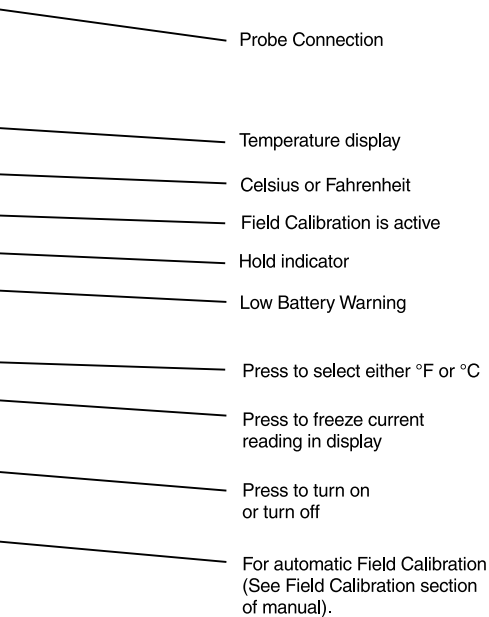

OPERATION

1. Press the **ON/OFF** key. The thermometer performs a self-test and all display digits and indicators, as shown below, should remain on for approximately two seconds.

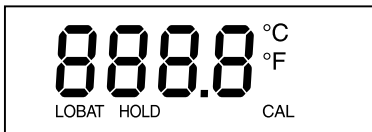

2. If a probe is not connected or if the probe is defective, the display will indicate "oPEn".
3. Select °C or °F by pressing the **°C/°F** key. Temperature scale can be switched at any time. The thermometer retains the last selected scale the next time you turn the power on.
4. For optimum instrument accuracy, allow one minute for ambient temperature stabilization. If the unit has been stored at an extreme ambient condition, more time will be needed.

When taking temperature measurements, allow time for the reading to stabilize. Multiplying the time constant of the probe by 5 will give you the approximate time required.

If desired, press the **HOLD** key to retain the reading on the display. Press **HOLD** key again for normal operation.

The display will show "Ur" (under range) or "Or" (over range) if the temperature reading is out of range of the instrument.

FIELD CALIBRATION

The thermometer is factory calibrated and does not require calibration before use. The CAL function allows single point calibration of the thermometer, at 0°C (32°F) to compensate for probe offset error. It is not necessary to perform a field calibration to obtain specified meter accuracy. Use the field calibration feature to improve thermometer/probe accuracy.

1. Follow steps 1 through 4 in **FIELD CALIBRATION CLEAR/UNLOCK** section.
2. Pack sensing end of probe in a container tightly packed with crushed ice and filled with distilled water. Allow temperature to stabilize.
3. Press and release the **CAL** key to enter the calibration mode.
4. The display will momentarily show “CA” and then the temperature reading starts blinking.
5. If the measured temperature is from –5°C to 5°C (23 to 41°F), when the temperature reading is stable, press the **HOLD** key to confirm calibration.

The display will momentarily show “CO” and the reading will be set to 0°C (32°F). The CAL indicator will turn on, indicating a field calibration is active. *The field calibration is automatically locked as well.*

If “Err” is displayed, either the displayed reading is outside the above limits or the batteries are weak.

FIELD CALIBRATION CLEAR/UNLOCK

The calibration clear/unlock feature will cancel any previous field calibration (the thermometer reverts to the default factory calibration) and also enables the field calibration operation.

1. Turn the thermometer off.
2. Hold the **CAL** key down while pressing the **ON/OFF** key.
3. Unit will first display 8888 then the firmware version number.
4. When the **CAL** key is released, the unit will return to measurement mode.

FIELD CALIBRATION LOCKOUT

The calibration lockout feature prevents any field calibration changes. The lockout remains in effect until a clear/enable has been performed. Use the following procedures to lockout the field calibration operation.

Lockout Procedure

1. Turn the thermometer off.
2. Hold the **HOLD** key down while pressing the **ON/OFF** key.
3. Unit will first display 8888 then the firmware version number.
4. When the **HOLD** key is released, the unit will display 8888 and then turn off. (If field calibration is already locked, the unit will return to measurement mode.)

MAINTENANCE

Properly used, the thermometer should maintain calibration indefinitely and not require service other than occasional cleaning of the housing and changing of the batteries.

Do not clean with abrasives or solvents. Use mild detergents, never immerse nor use excessive fluid.

BATTERIES

If there is no display when the thermometer is turned on, check condition of the two AA batteries. Also check that the battery terminals are clean and batteries are properly installed. If replacement is necessary, refer to the BATTERY INSTALLATION AND REPLACEMENT section for replacement procedure.

SERVICE

There are no internal adjustments or user-replaceable parts.

Note: Serial number label is located inside battery compartment.

A-1925-37

Rev. 0

Printed in Singapore

68X309902

WARRANTY

The Manufacturer warrants this product to be free from significant deviations from published specifications. If repair or adjustment is necessary within the warranty period, the problem will be corrected at no charge if it is not due to misuse or abuse on your part as determined by the Manufacturer. Repair costs outside the warranty period, or those resulting from product misuse or abuse, may be invoiced to you.

The product is supplied with a 3-year warranty.

PRODUCT RETURN

To limit charges and delays, contact the seller or Manufacturer for authorization and shipping instructions before returning the product, either within or outside of the warranty period. When returning the product, please state the reason for the return. For your protection, pack the product carefully and insure it against possible damage or loss. Any damages resulting from improper packaging are your responsibility.

TECHNICAL ASSISTANCE

If you have any questions about the use of this product, contact the Manufacturer or authorized seller.

Trademarks bearing the ® symbol in this publication are registered in the U.S. and in other countries.